

# M5 系列 手鈕作動閥

series MANUALLY SELECTION SWITCH VALVE

二 · 三方口機械閥  
2,3 way Mechanical Valve

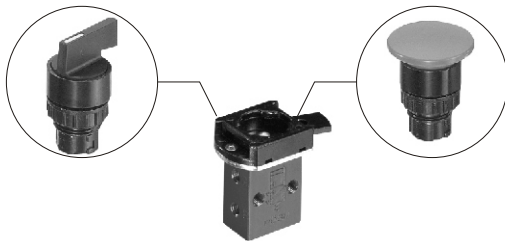

## 規格表 Specifications

接管口徑 Port thread size (G)	M5	
位置數 Port amount	2/2	3/2
使用流體 Used fluid	空氣 Air	
最大流量 Maximum flow (ℓ/min)	110	
使用溫度 Ambient temperature (°C)	0 ~ 60	
重量 Weight (g)	180	

開關頭部選用鋅合金本體  
Head of the switch made of zinc alloy

## 訂購代號 Order No.

**H 3 M5 S 2 22**

● 安裝直徑 Caliber

22	φ 22
30	φ 30

● 顏色 Color

2	黑 Block
3	綠 Greed
4	紅 Red

● 接管口徑 Port Size

● 方口數 Port amount

2		2/2
3		3/2

● 頭部型狀 Head of form

<b>S</b>	短柄 Short handle	
<b>L</b>	長柄 Long handle	

● 作動閥樣式 Type

**P 3 M5 F 2 22**

● 安裝直徑 Caliber

22	φ 22
30	φ 30

● 顏色 Color

2	黑 Block
3	綠 Greed
4	紅 Red
6	藍 Blue

● 接管口徑 Port size

● 方口數 Port amount

2		2/2
3		3/2

● 頭部型狀 Head of form

<b>F</b>	平頭 Flat	
<b>P</b>	凸頭 Protruding	
<b>M</b>	蘑菇 Mushroom	
<b>MX</b>	大蘑菇 Big mushroom	
<b>L</b>	停駐型 Latching	
<b>K</b>	停駐附鎖型 Latching and key	

● 作動閥樣式 Type

機械閥 Mechanical Valve

**V-3-M5**

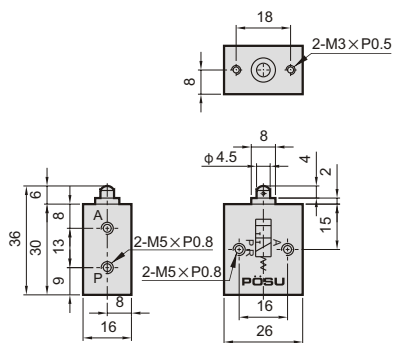

**PH-05**

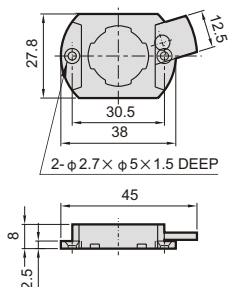

**PH-04-S**

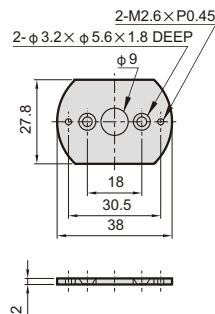

**H<sub>P</sub>-3-M5-□-□-□**

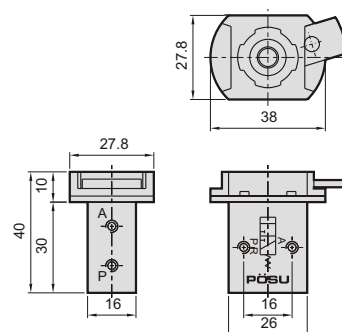

**H-3-M5-S-□-22** 短柄手鈕作動閥

Short handle

**H-3-M5-S-□-30**

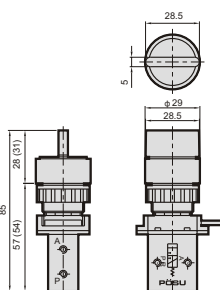

Symbol

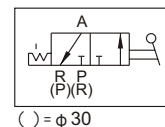

**H-3-M5-L-□-22** 長柄手鈕作動閥

Long handle

**H-3-M5-L-□-30**

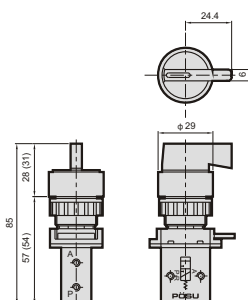

Symbol

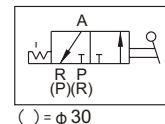

**P-3-M5-F-□-22** 平頭手鈕作動閥

Flat

**P-3-M5-F-□-30**

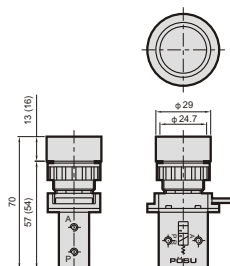

Symbol

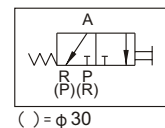

**P-3-M5-P-□-22** 凸頭手鈕作動閥

Protruding

**P-3-M5-P-□-30**

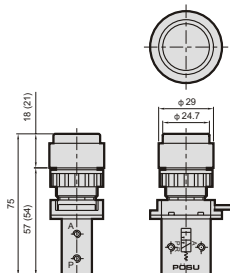

Symbol

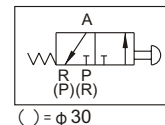

機械  
氣動  
閥

機械閥 Mechanical Valve

**P-3-M5-M-□-22** 蘑菇手鈕作動閥

Mushroom

**P-3-M5-M-□-30**

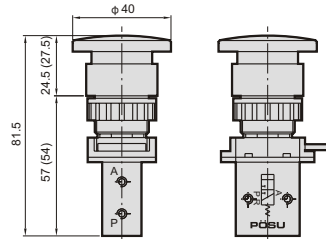

Symbol

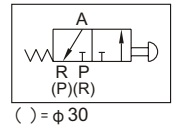

**P-3-M5-MX-□-22** 大蘑菇手鈕作動閥

Big mushroom

**P-3-M5-MX-□-30**

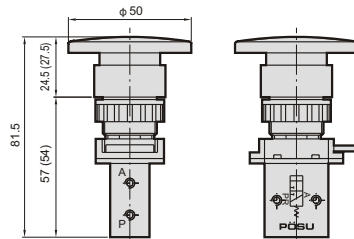

Symbol

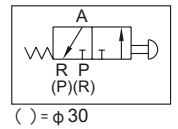

**P-3-M5-L-□-22** 停駐型手鈕作動閥

Latching

**P-3-M5-L-□-30**

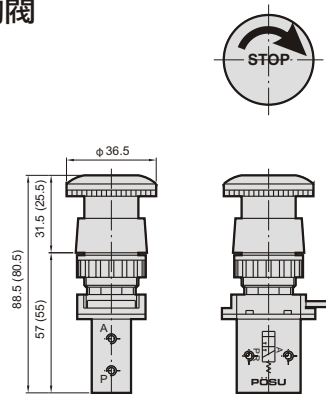

Symbol

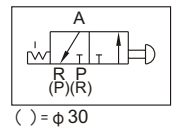

**P-3-M5-K-□-22** 停駐附鎖型手鈕作動閥

Latching and key

**P-3-M5-K-□-30**

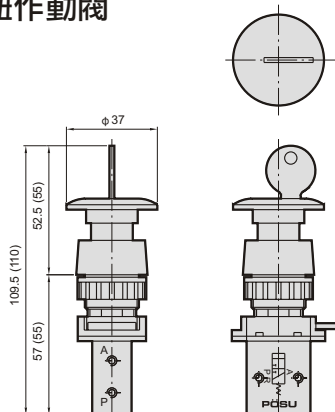

Symbol

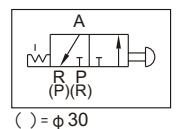

Head Of The Switch

尺寸圖 Dimension



H-S



H-L



P-F



P-P



P-M



P-MX



P-L



P-K

**H-S-□-22**

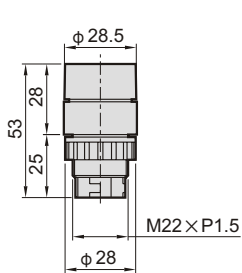

**H-L-□-22**

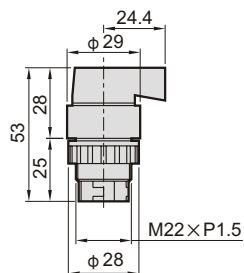

**P-F-□-22**

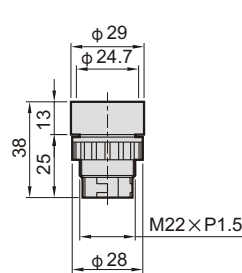

**P-P-□-22**

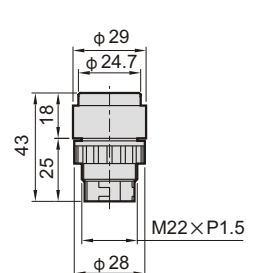

**P-M-□-22**

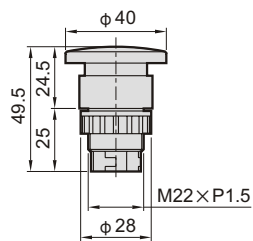

**P-MX-□-22**

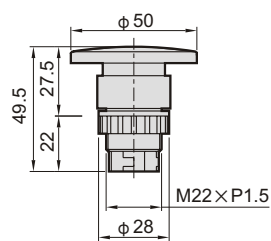

**P-L-□-22**

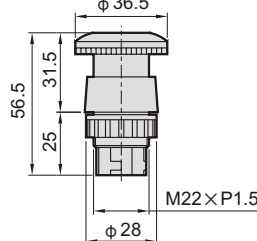

**P-K-□-22**

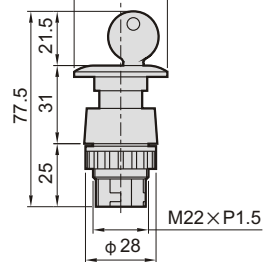

**H-S-□-30**

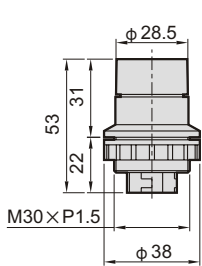

**H-L-□-30**

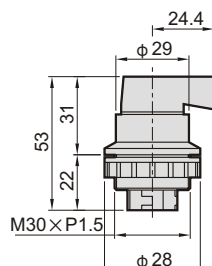

**P-F-□-30**

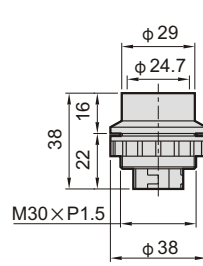

**P-P-□-30**

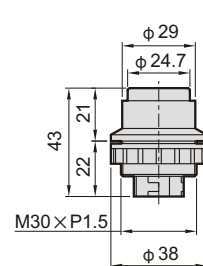

**P-M-□-30**

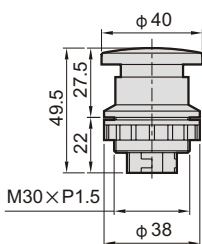

**P-MX-□-30**

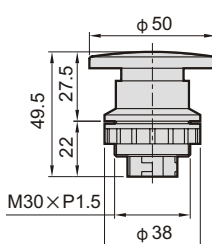

**P-L-□-30**

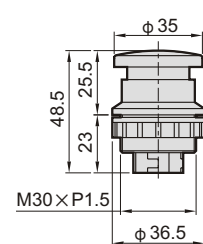

**P-K-□-30**

