

G1/8

系列 手鈕作動閥

series MANUALLY SELECTION SWITCH VALVE

二・三方口機械閥
2,3 way Mechanical Valve



規格表 Specifications

接管口徑 Port thread size (G)	1/8"	
位置數 Port amount	2/2	3/2
使用流體 Used fluid	空氣 Air	
最大流量 Maximum flow (ℓ/min)	NC:300	NO:320
使用溫度 Ambient temperature (°C)	0 ~ 60	
重量 Weight (g)	180	

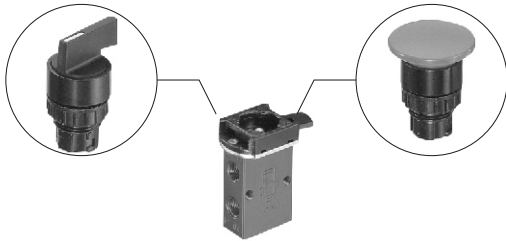

開關頭部選用鋅合金本體
Head of the switch made of zinc alloy

訂購代號 Order No.

H 3 1/8 S 2 22

- 安裝直徑 Caliber

22	φ 22
30	φ 30
- 顏色 Color

2	黑 Block
3	綠 Greed
4	紅 Red
- 接管口徑 Port Size
- 方口數 Port amount

2		2/2
3		3/2
- 頭部型狀 Head of form

S	短柄 Short handle	
L	長柄 Long handle	
- 作動閥樣式 Type

P 3 1/8 F 2 22

- 安裝直徑 Caliber

22	φ 22
30	φ 30
- 顏色 Color

2	黑 Block
3	綠 Greed
4	紅 Red
6	藍 Blue
- 接管口徑 Port size
- 方口數 Port amount

2		2/2
3		3/2
- 頭部型狀 Head of form

F	平頭 Flat	
P	凸頭 Protruding	
M	蘑菇 Mushroom	
MX	大蘑菇 Big mushroom	
L	停駐型 Latching	
K	停駐附鎖型 Latching and key	
- 作動閥樣式 Type

機械閥 Mechanical Valve

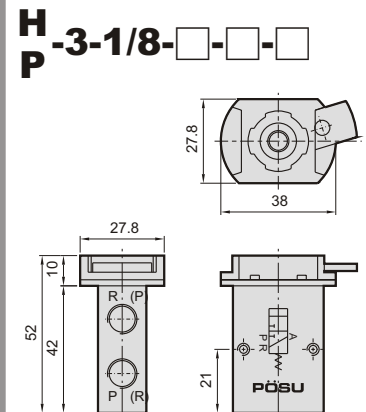
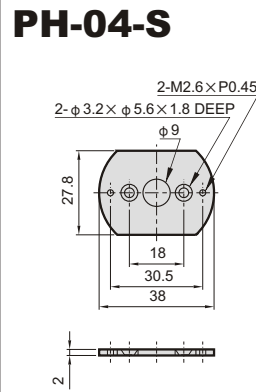
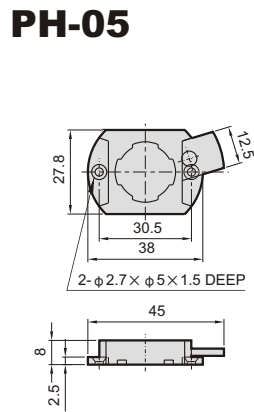
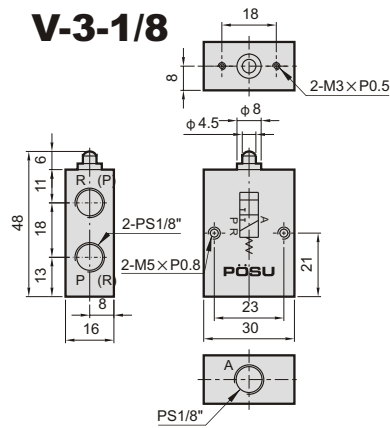

H-3-1/8-S-□-22 短柄手鈕作動閥
H-3-1/8-S-□-30 Short handle

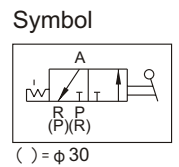
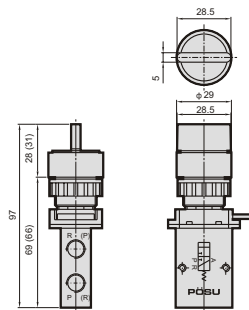

H-3-1/8-L-□-22 長柄手鈕作動閥
H-3-1/8-L-□-30 Long handle

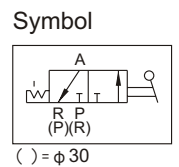
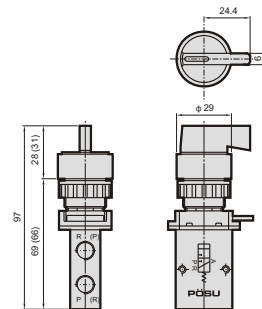

P-3-1/8-F-□-22 平頭手鈕作動閥
P-3-1/8-F-□-30 Flat

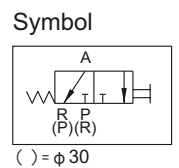
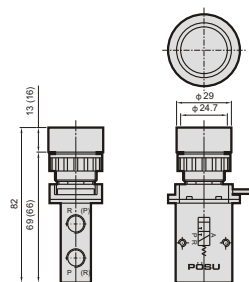

P-3-1/8-P-□-22 凸頭手鈕作動閥
P-3-1/8-P-□-30 Protruding

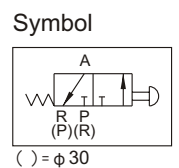
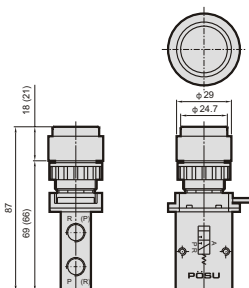

機械閥 Mechanical Valve

P-3-1/8-M-□-22 蘑菇手鈕作動閥

Mushroom

P-3-1/8-M-□-30

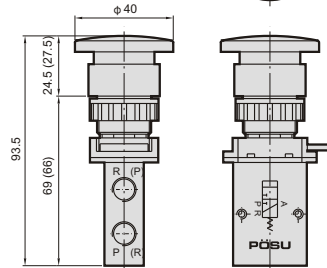

Symbol

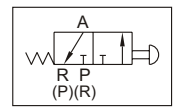

() = $\phi 30$

P-3-1/8-MX-□-22 大蘑菇手鈕作動閥

Big mushroom

P-3-1/8-MX-□-30

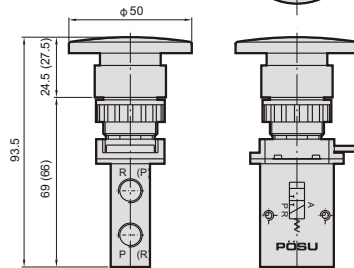

Symbol

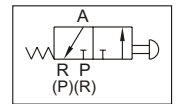

() = $\phi 30$

P-3-1/8-L-□-22 停駐型手鈕作動閥

Latching

P-3-1/8-L-□-30

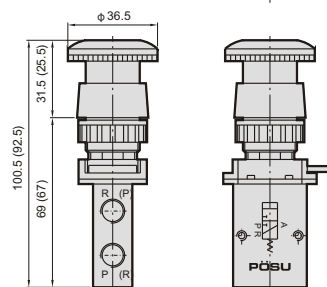

Symbol

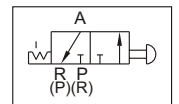

() = $\phi 30$

P-3-1/8-K-□-22 停駐附鎖型手鈕作動閥

Latching and key

P-3-1/8-K-□-30

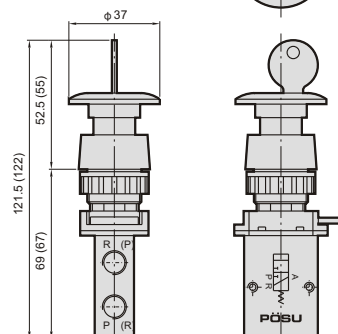

Symbol

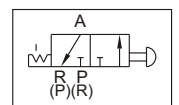

() = $\phi 30$

機械氣動閥

Head Of The Switch

尺寸圖 Dimension



H-S



H-L



P-F



P-P



P-M



P-MX



P-L



P-K

H-S-□-22

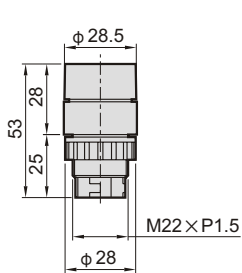

H-L-□-22

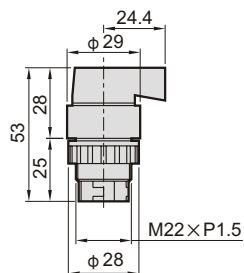

P-F-□-22

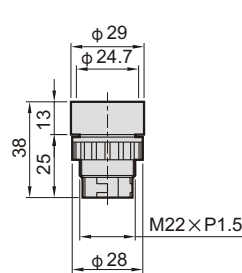

P-P-□-22

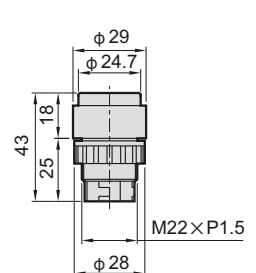

P-M-□-22

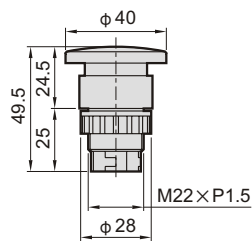

P-MX-□-22

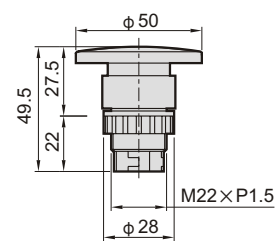

P-L-□-22

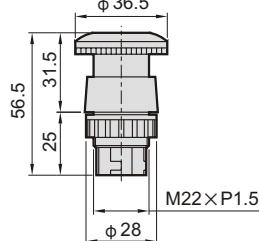

P-K-□-22

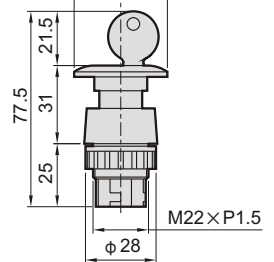

H-S-□-30

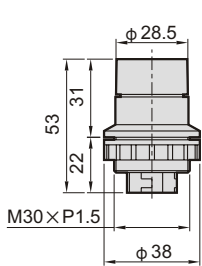

H-L-□-30

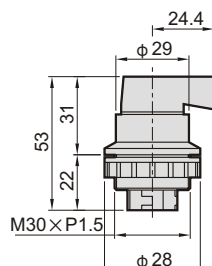

P-F-□-30

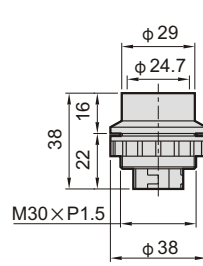

P-P-□-30

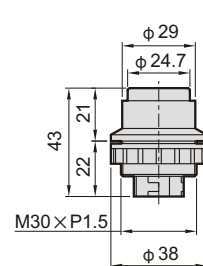

P-M-□-30

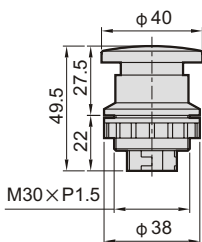

P-MX-□-30

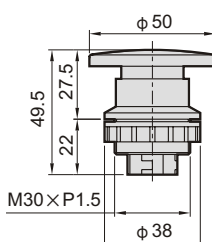

P-L-□-30

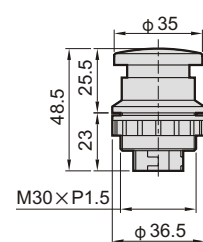

P-K-□-30

